

# HUSSECHUCK /SHIELD

User manual



Powder extinguisher – 4kg/6kg

TI62P4VSH/ TI62P4VSS, TI62P6VSH/ TI62P6VSS

Foam extinguisher – 6kg

TS62F6VSH/ TS62F6VSS

Dear Customer,

thank you for choosing our fire extinguisher.

We hope that it brings peace of mind and a sense of security to your home and that it is used "only" as an original feature there throughout the whole of its lifetime.



# General instructions

01

## Introduction

Read this entire manual carefully before installing the unit or before using it for the first time.

Pass this information on to other users of the extinguisher.

Only pass on the extinguisher to third parties with this user manual.

02

## Product features

A fire extinguisher is a pressure and safety device. Its use is governed by not only by these instructions but also by special legal regulations, which in their current version are superior to these instructions

This extinguisher is designed exclusively for small and starting fires. Use for other purposes and any changes in the design, filling or marking of the device are not permitted.

A fundamental feature in the placement of SHIELD AND HUSSECHUCK fire extinguishers is understanding their orientation.

SHIELD AND HUSSECHUCK fire extinguishers should be seen as a cabinet and a fire extinguisher in one. The back side of the fire extinguisher forms a shield (the "box"), the front side only appears after the body of the fire extinguisher is folded back by 90°.

This folding (opening) is made possible by a special suspension hinge with suspension elements for the body of the fire extinguisher.

After opening/unfolding, the user sees the front side, where the instructions, information on inspection and revisions and the control elements of the fire extinguisher are located (mandatory information and instruction elements – pictograms).

That is why the Ampla fire extinguisher is equipped with a label with a pictogram that identifies the device intended for extinguishing fires.

The pictogram label is an integral part of the device. It may be removed only if it is replaced by a standard pictogram of larger dimensions placed in a prominent position.

03

## Obligations of the owner of the device

It is the responsibility of the owner or user of the property or vehicle to train regular users and to allow random users to learn how to use the fire extinguisher.

It is the owner's responsibility to prevent children from handling the fire extinguisher. Fire extinguishers may not be operated independently and without proper training by a person under 15 years of age.

It is the owner's responsibility to observe the service intervals described on the warranty card in the Inspection and Servicing section.

04

## Intended use

The fire extinguisher must not be misused for purposes other than fire fighting.

The extinguisher must be used in accordance with the operating instructions according to the pictograms on the type plate.

The extinguisher may not be covered or moved and the extinguisher pictogram marking must remain legible.

If the extinguisher is removed from the holder for any purpose other than inspection, maintenance of the extinguisher, or maintenance of the structure, the warranty shall be void.

The extinguisher vessel may only be used as an extinguisher vessel.

05

## Standard and safety instructions

The fire extinguisher must be placed in accordance with the relevant standards and in number at least according to the separately prepared fire safety solution of the building to meet the required fire extinguishing efficiency.

No other objects shall be placed in front of or under where the extinguisher is placed that would restrict its removal from the wall holder or stand.

The vessel of the device is under constant pressure. The extinguisher must not be exposed to external forces, must not be forced open and any manipulation other than its intended use is prohibited.

Do not expose the extinguisher to direct sunlight and radiation. Do not expose the instrument to corrosive substances, water or moisture.

06

## Cleaning and care

The fire extinguisher must be kept clean by the responsible user or owner. It must not be covered or moved and the marking must remain legible.

Do not use any aggressive cleaning agents or abrasives for cleaning.

We recommend cleaning the varnished surfaces with a damp microfibre cloth.

Dust textile surfaces regularly with a vacuum cleaner.

If a fire extinguisher is removed for building maintenance, it must be stored safely during this time so that it cannot be damaged or cause injury to others.

07

## Maintenance

A damaged fire extinguisher, or part thereof, and in particular a damaged or corroded container, may only be dismantled by an authorized person servicing portable fire extinguishers who has been trained by the manufacturer (hereinafter referred to as "authorized person"). Damage to the container must always be reported immediately to the manufacturer, dealer or inspection technician.

It is forbidden to make any modifications or repairs to the device container, such as soldering or welding.

08

## Inspection and servicing

Inspection and servicing of the fire extinguisher is required by the applicable statutory regulations and standards and may only be carried out by an authorized person. You can find a list of authorized service technicians on our website [ampla.com](http://ampla.com). More information can be found on a separate product tab.

09

## Service life

Service life of the extinguisher, i.e. the toroidal pressure vessel assembly, valve, riser tube, pressure gauge, hose and nozzle is 5 years. The service life of the pressure vessel is 20 years and is calculated from the date of manufacture permanently stamped on the vessel.

10

## Warranty

The Ampla fire extinguisher has been manufactured with the utmost care, according to strict standards and has been subjected to an output inspection prior to shipment. If your device is still defective, you may be able to exercise your legal rights against the seller. Your legal rights are not limited by our warranty specified below.

This warranty covers defects in materials or manufacturing defects.

It does not apply to parts of the product subject to wear and tear, nor to damage caused by improper use of the product.

The manufacturer guarantees the quality and performance of the product and provides this guarantee only if the manufacturer's installation, use, inspection and maintenance procedures are followed.

Installation must be carried out according to the instructions in this User manual. If the prescribed installation conditions are not observed, the warranty claim cannot be accepted by the manufacturer.

## Package contents

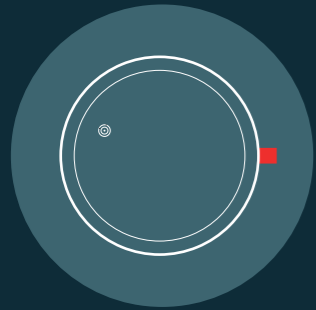

### Fire extinguisher

Complete filled and pressurised working extinguisher with first output inspection.

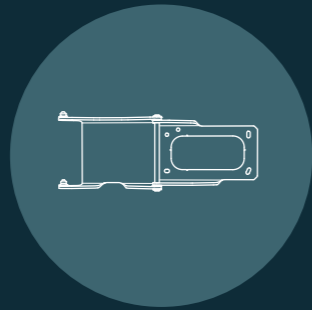

### Device holder

For mounting the extinguisher on a vertical structure.

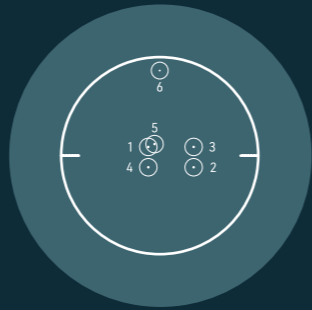

### Mounting template

A tool for precise marking of mounting holes in a vertical structure.



### Magnet

To securely fix the closed position of the extinguisher.



### Screws

1x screw 4x40 for hole 6,  
5x screw 5x60 for holes 1-5  
(see template).



### Instructions

## Anchoring material



Included in the package are dowels Fischer UX 8 for solid masonry. Anchoring material for other types of supporting structures should be consulted with the professional staff of a specialist shop.

You will need 5 pcs of anchoring material for the screw 5, and 1 pcs for the screw 4.

The total load capacity of the anchoring material for holes 1-5 must be at least 100 kg!

## Device location



The installation of the fire extinguisher may only be carried out:

- in accordance with applicable fire protection regulations
- in an environment not affected by the weather
- within the appropriate approved temperature range as indicated on the device's type plate.

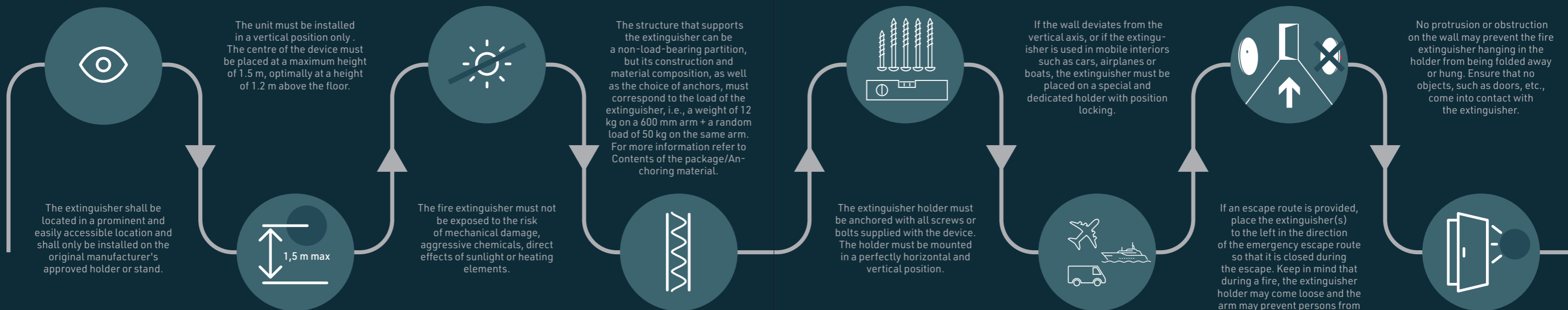

## Device installation



### Select a location

where your fire extinguisher will look best. Have a cup of coffee and take your time. You can use our template to select a suitable location.

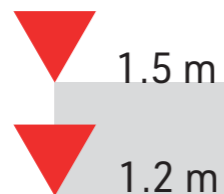

### Measure the zone

for installation. Its upper boundary will be at a height of 1.5 m and the lower boundary at a height of 1.2 m. Perfect accuracy is not necessary.

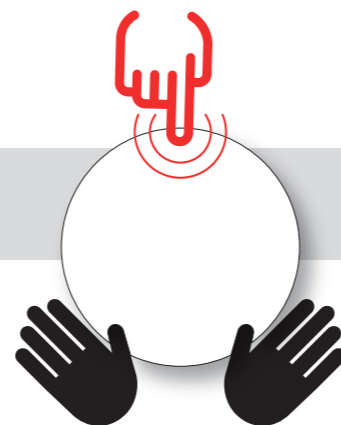

### Place the template

so that its centre is in the installation zone. Attach the template at the highest point.

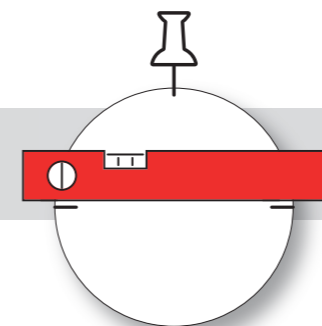

### Place a spirit level

to the axis of the template. Adjust the template to a perfectly horizontal position and fix its position.

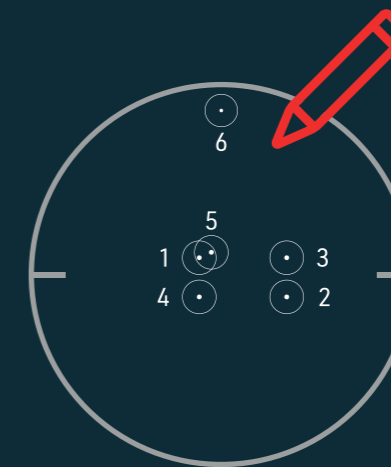

### Mark

holes for drilling through the template.

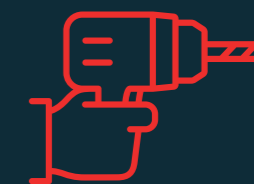

### Drill

holes corresponding to your anchoring material (see chapter Package contents/Anchoring material).

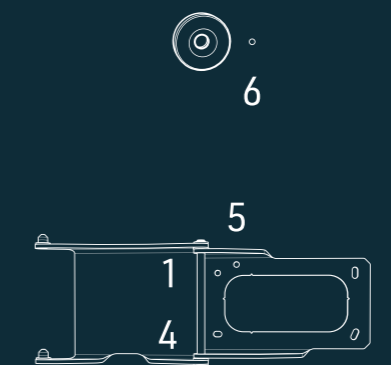

### Screw

the holder in holes 1-5 in the order indicated. Before tightening completely, double check that it is horizontal. Then screw the magnet into hole 6.

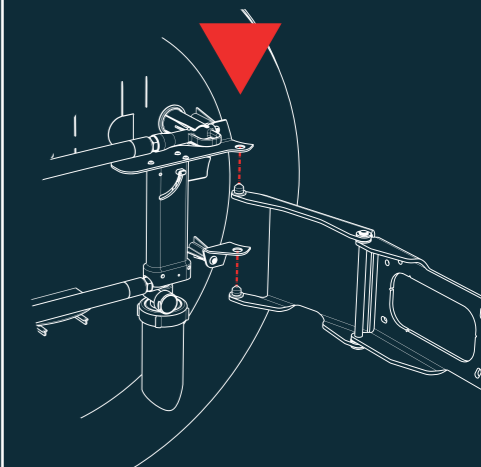

### Hang up

the toroid of the extinguisher to the pins of the holder.

## Use

general instructions



### Heavy

Handle the extinguisher with due regard to its heavy weight to avoid injury.



### Only the left

The Ampla fire extinguisher is designed for gripping with the left hand only.



### Vertically

The extinguisher can be carried vertically.

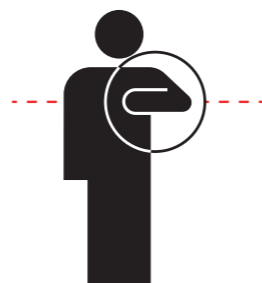

### Horizontally

You have to hold the extinguisher horizontally while extinguishing to keep the extinguishing media pumped evenly and in full volume.

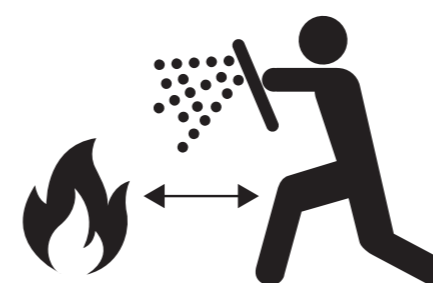

### Keep your distance

from the burning object. Do not aim the extinguishing media at one point, but cover the entire fire area evenly. Interrupt the extinguishing agent flow by repeatedly releasing and pulling the trigger.



### Use the hose

to extinguish small fire outbreaks when you want to aim precisely.



### Use the shield

and take cover behind it if the fire is large and action needs to be taken quickly.



## Call the fire brigade

Do not overestimate your strength when extinguishing the fire and always call the fire brigade even when the fire has already been extinguished. When a fire burns, oxygen is consumed in the room and toxic fumes are produced, which can cause you to fall unconscious or suffocate.

Do not endanger other persons with fire extinguisher. Vision and breathing may be impaired, resulting in paralysis or even death. If eyes or the respiratory tract are affected, get medical attention immediately.

# Use

practical part

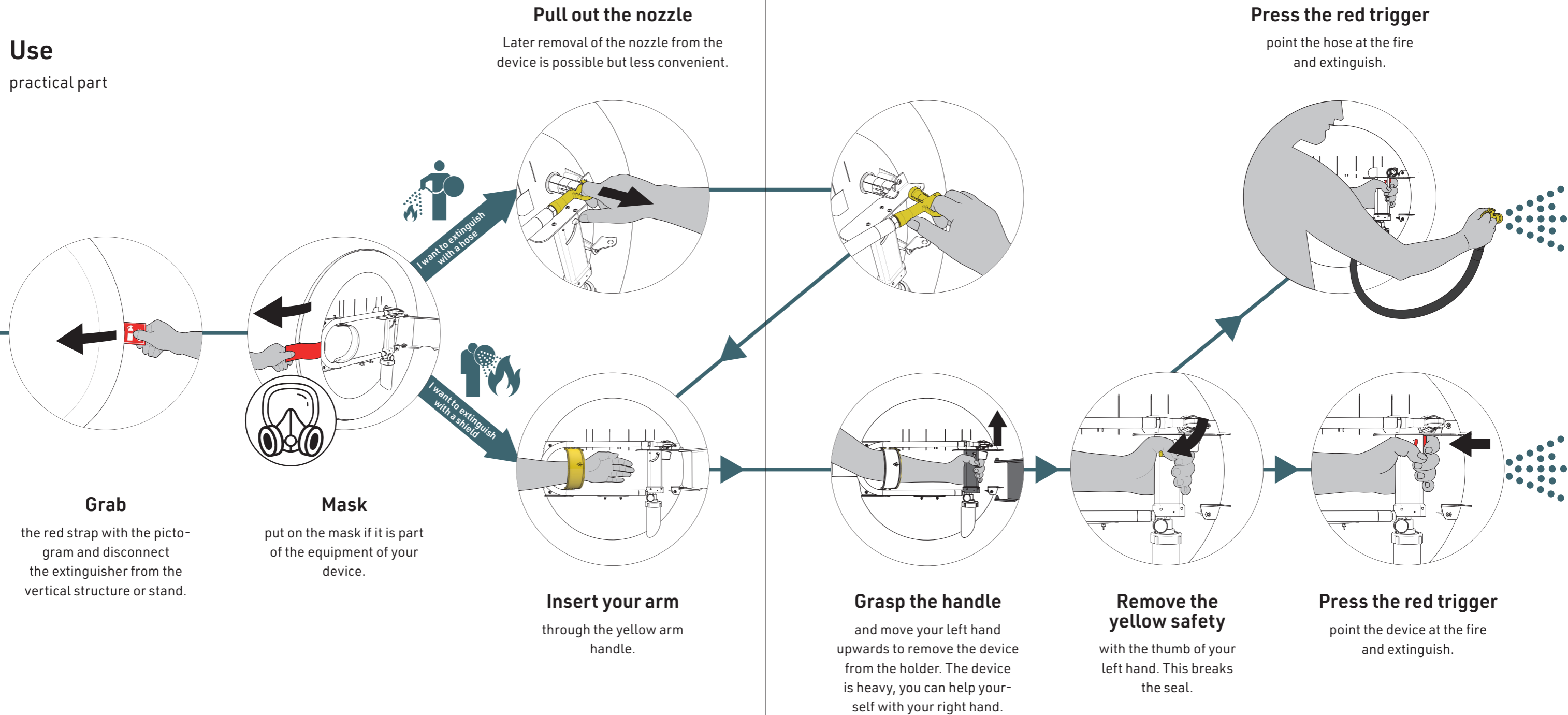



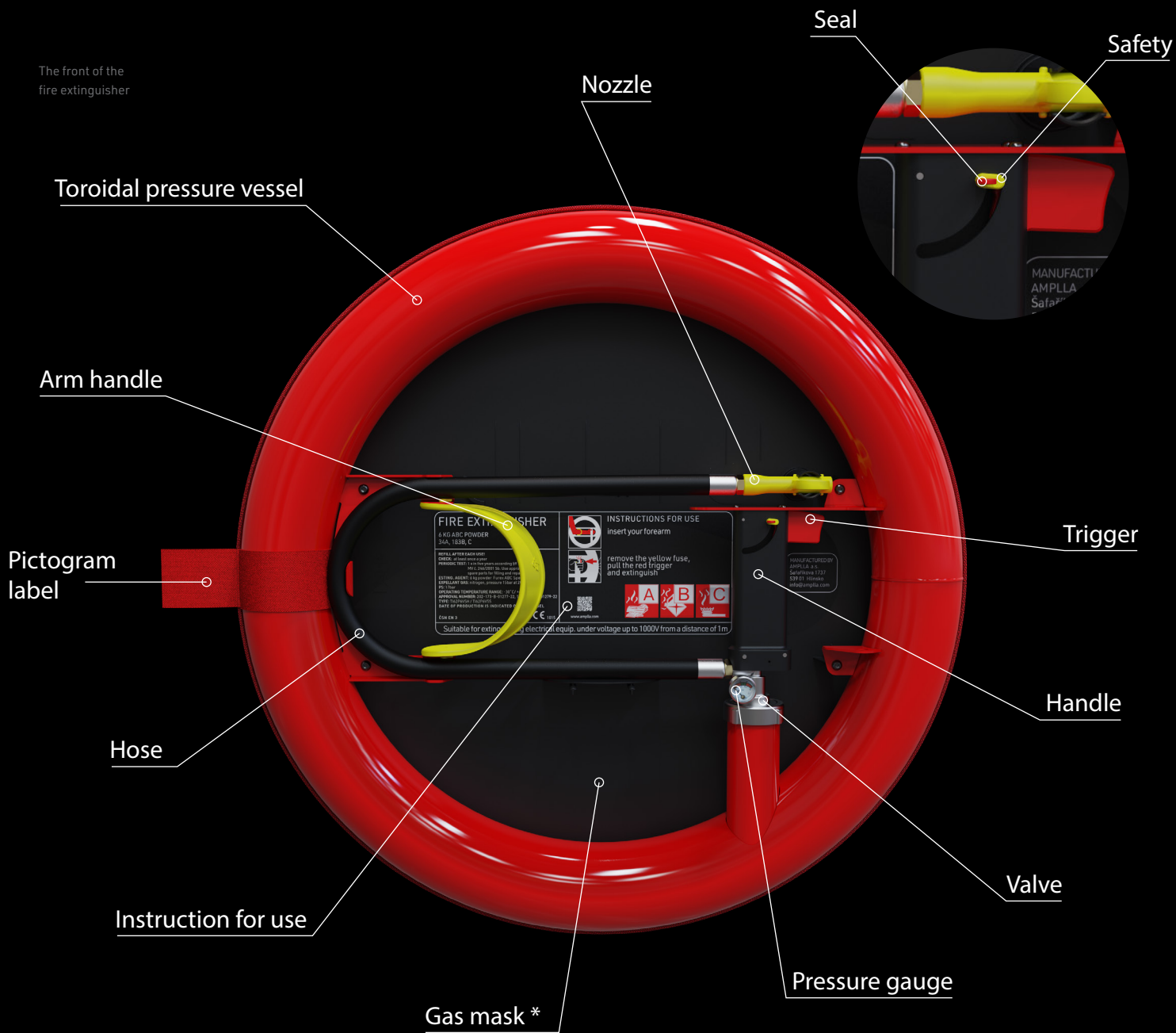

\*) if it is part of the fire extinguisher

